

WS-PRIMER MAINTENANCE PROCEDURE

GRAVITY SPRAY GUN SMART GUIDE

a good start is halfway to success.

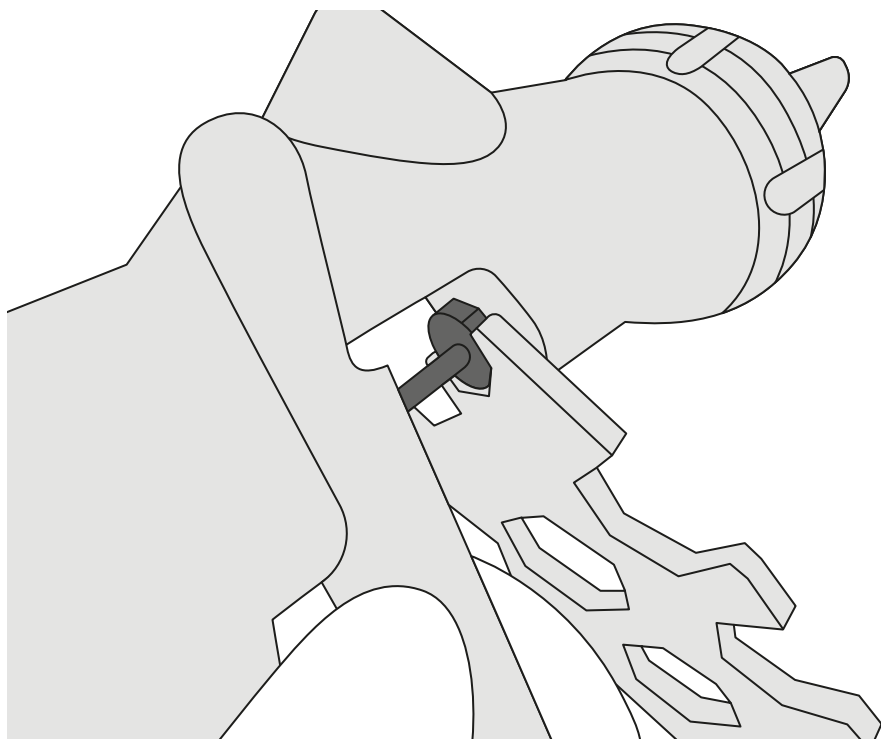

To obtain excellent painting results, it is not only necessary to have a good hand and an excellent device, but above all it is essential to take care to carry out constant maintenance on your spray gun.

This activity is often put in the background, neglecting the fact that defects of painting very often depend on poor cleaning and lack of maintenance. Neglecting this important activity could cause premature wear and corrosion of the most important parts of your product.

This simple and accurate activity done daily, explained by a few simple following steps, guarantees the equipment considerable efficiency in its performance and greater durability over time.

IMPORTANT!

During all phases of maintenance procedures, always wear proper body and respiratory protection such as: ANEST IWATA safety glasses, mask and gloves.

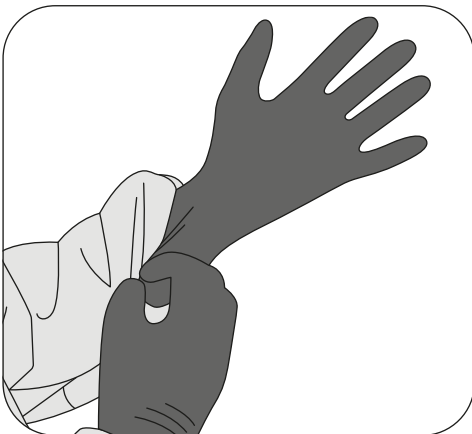

MAIN MAINTENANCE PROCEDURE

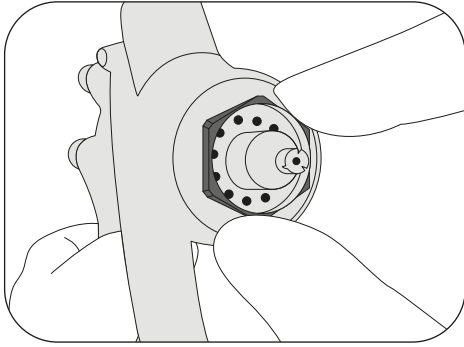

1 Reassemble the fluid nozzle tightening it manually into its seat.

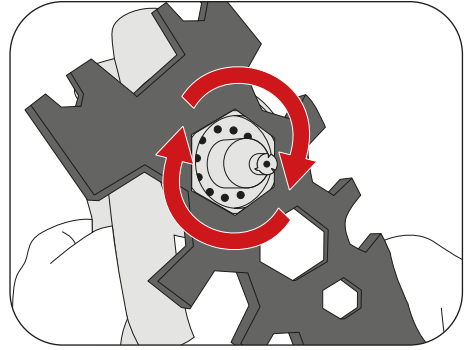

2 Tighten it further clockwise with the universal spanner.

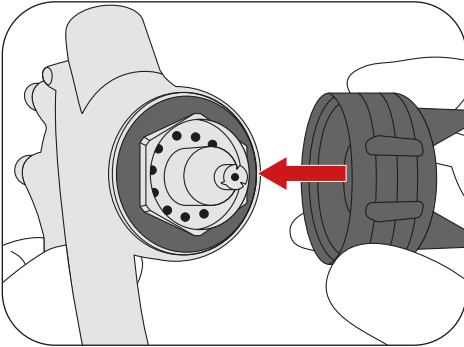

3 Reassemble the air cap.

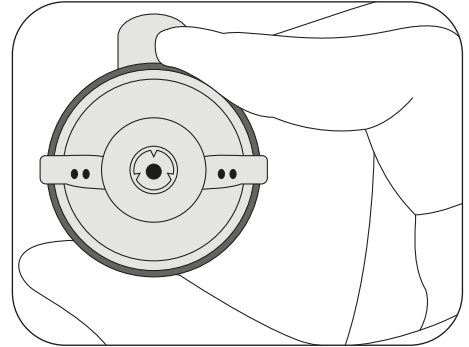

4 Once reassembled, align the air cap horizontally and tighten it by hand.

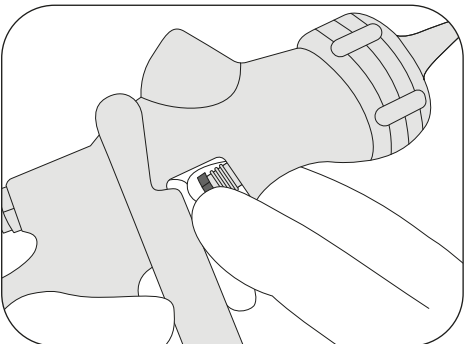

5 Place the self-adjusting needle packing in its seat and tighten it manually.

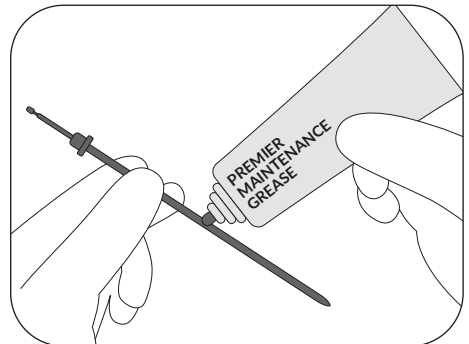

6 Lubricate the fluid needle with a small amount of maintenance grease.

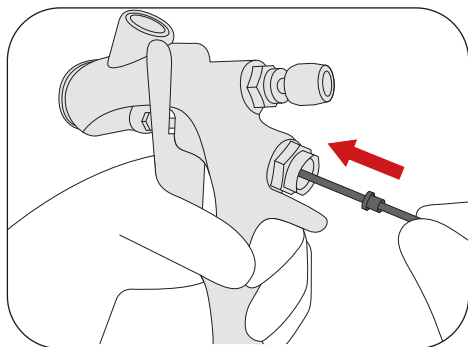

- 7** Insert the lubricated fluid needle set carefully into its seat.

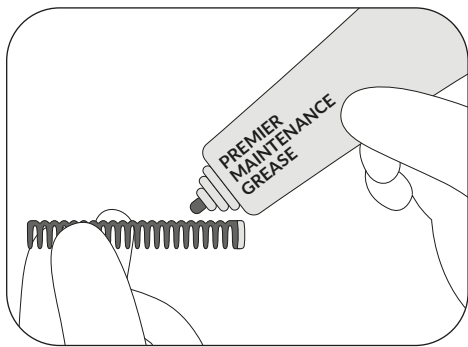

- 8** Lubricate the fluid needle spring with a small amount of maintenance grease.

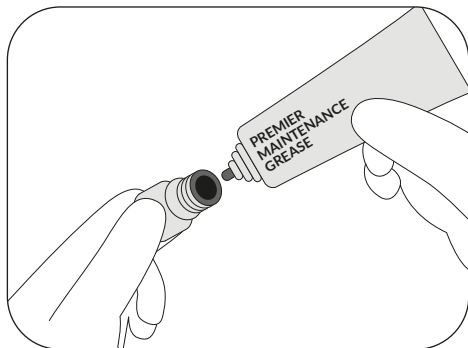

- 9** Lubricate the fluid needle adj. knob with a small amount of maintenance grease.

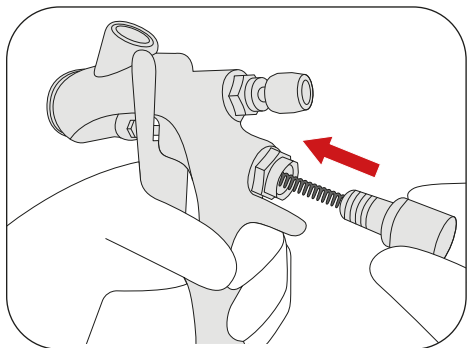

- 10** Reassemble in the following order: the needle spring and then the fluid adj. knob set.

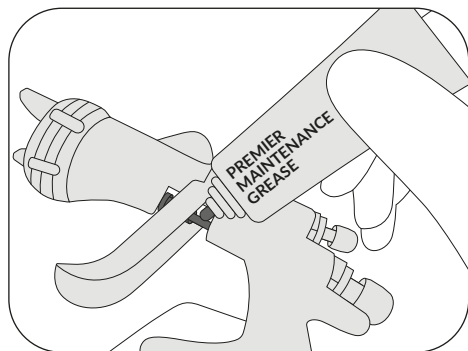

- 11** Apply a small amount of grease to the fluid needle in the trigger slide area.

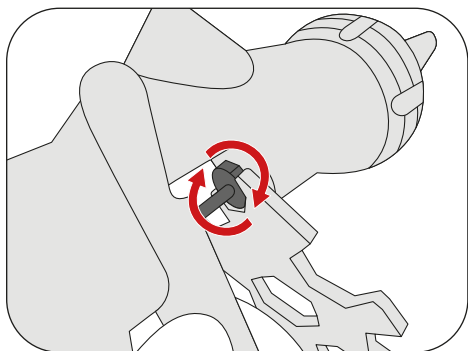

- 12** Now attend to the adjustment of the fluid needle packing. Screw the needle packing nut tight by the spanner until the needle starts to stick.

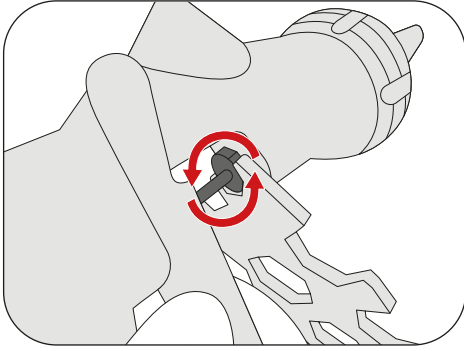

13 Once the needle sticks, unscrew the needle packing (counter-clockwise) until the needle just moves freely again.

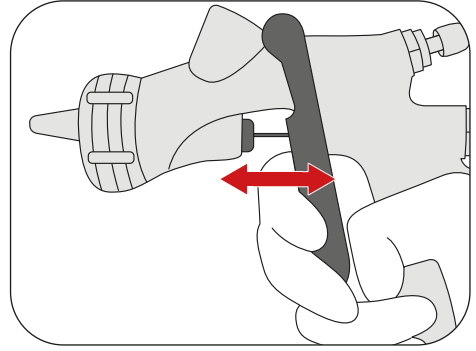

14 Check the smooth sliding of the fluid needle by pulling the trigger few times.



Get help with ANEST IWATA SUPPORT
www.anest-iwata-coating.com/support/



G R A V I T Y S P R A Y G U N S M A R T G U I D E